

REV	ECN NO.	DETAILS	BY	DATE
1	AO	new version release	LZH	2022.09.01
2				
3				

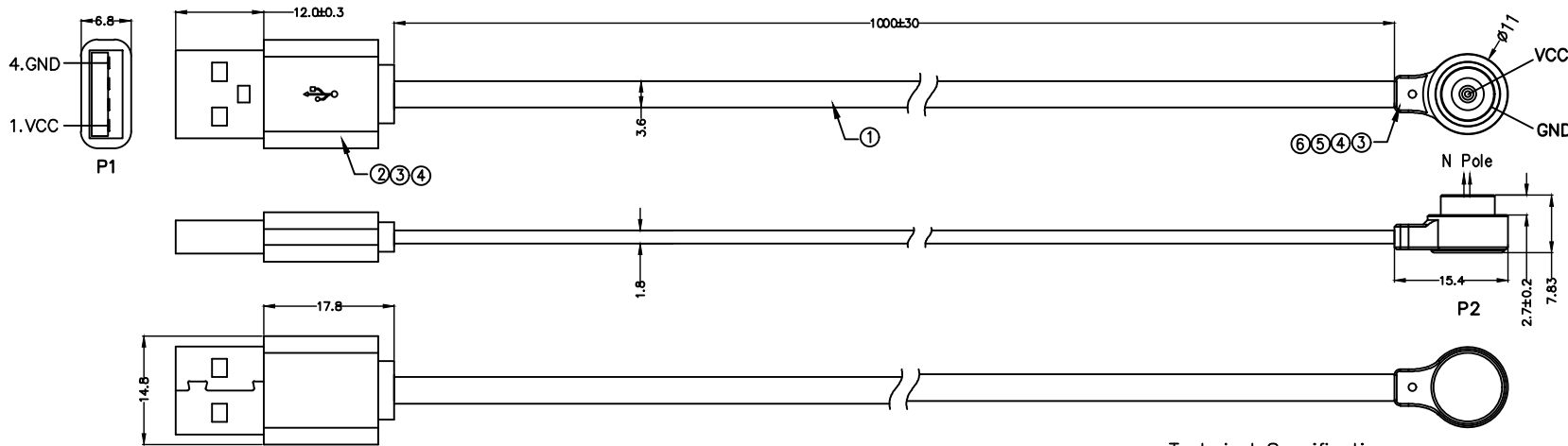

**Wiring Table**

P1	P2
1 Natural	VCC
4 Green	GND

**Technical Specification:**  
 1.a.100% break/short test.  
 a.On-resistance: 2 $\Omega$  (max).  
 b.Insulation resistance: 300V/DC 10M $\Omega$ (min).  
 2.Swing test: 200g lifting weight,  $\pm$ 60 degrees 30 times/min, 2000 times conduction OK.  
 3.Rated voltage (PIN contact): 5Volts  
 4.Rated current (PIN contact): 2A maximum  
 5.Working elastic single PIN:  
 1).Press stroke 0.8mm (PIN contact): 60gfMax  
 6.Life test:  
 1)Press stroke 0.8mm, 10,000 times (Min)  
 7.0 Operating temperature range: -30~85 $^{\circ}$ C  
 8.0 is marked with "\*" as a key dimension.  
 9.0Environmental Requirements: RoHS2.0.

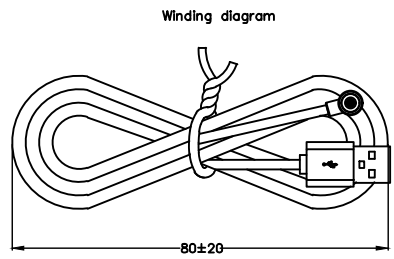
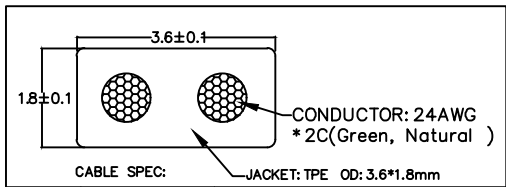

Item	Part Name	Material	Finish	Q	TY	Remark
6	PCB	FR-4 5V 2A	7.4/M round water cup PCB	1pcs	-	
5	Connector	7.4mm-YY 2P/M white LCP	PIN gold-plated 5u"	1pcs	-	
4	Outer mold	white TPE 90A	-	8g	-	
3	Internal mold	LD-PE transparent	-	3g	-	
2	USB2.0 Plug	PBT White+Brass	Pin gold plating G / F Nickel-plated iron shell	1pcs	-	
1	Wire rod	Enameled wire TPE outer quilt	Enameled wire*2C (green, natural color)	1.0M	white OD: 3.6*1.8mm	

"UNLESS OTHERWISE STATED ALL DIMENSIONS ARE IN MILLIMETRES  
 LINEAR TOLERANCE:  
 X,±0.20 .X±0.15 .XX±0.10  
 X\*,±2° .X\*±0.5°"  
 Pomagtor  
 Website:www.pomagtor.net

**POMAGTOR**  
 POGO PIN - 16 YEARS OF PROFESSIONAL  
 Magnetic connector-professional for customization

TITLE	Male magnetic wire	REV	AO	DRAWN BY	LZH	CHECKED BY	-	APPROVED BY	-
SPEC	USB A/M TO 7.4mm/M L=1.0M White+PTC	SCALE	1						
PART NO	RD90.LZH0220901-003	UNIT	mm						
VEIW ANGLE		DATE	2022.09.01						
		SHEET	1 of 1						

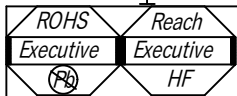

REV	ECN NO.	DETAILS	BY	DATE
1	AO	new version release	LZH	2022.09.01
2				
3				

包装作业示意图  
一、扎线;装PE袋

扎线图

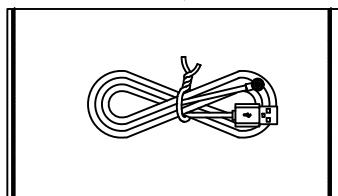
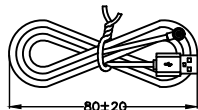

二、装吸塑盘  
每盘装64PCS

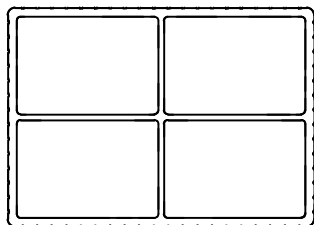

三、装纸箱, 每个吸塑盘配放一个隔板  
1箱=4PCS吸塑盘+4PCS隔板

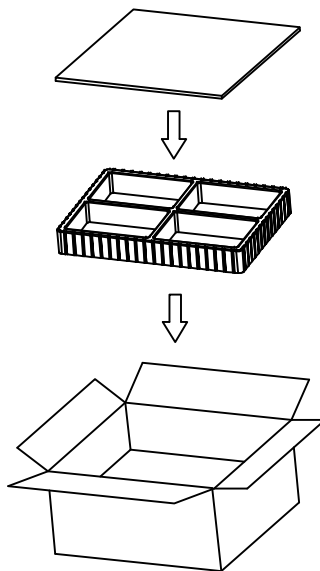

四、封纸箱  
纸箱按“工”字型封透明胶纸

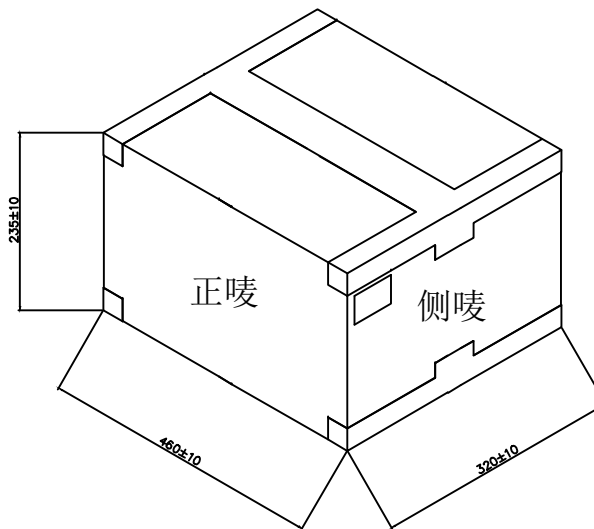

序号	物料编码	品名	规格描述	用量
5	HY124.K9K00-01	隔板	平面隔板 材质:K9K 尺寸:430*W:310*T:1.7mm	1/64
4	HY13.ZX001-007	纸箱	L:460*W:320*H:235mm 材质:K-K 正唛无LOGO, 侧唛印向上LOGO	1/325
3	HY102.00010-01	吸塑盘	线材通用吸塑造盘 L:420*W:300*T:55mm PET:0.5mm	1/64
2	-	自封袋	-	1pcs
1	RD90.LZH0220901-003	磁吸线	-	1pcs

"UNLESS OTHERWISE STATED  
ALL DIMENSIONS ARE IN  
MILLIMETRES  
LINEAR TOLERANCE:  
X,±0.20 .X±0.15 .XX±0.10  
X\*,±2° .X\*±0.5°"  
Pomagtor  
Website:www.pomagtor.net

**POMAGTOR**  
POGO PIN - 16 YEARS OF PROFESSIONAL  
Magnetic connector - professional for customization

TITLE	磁吸线 吸塑盘包装	REV	AO	DRAWN BY	LZH	CHECKED BY	-	APPROVED BY	-
SPEC	USB A/M TO 7.4mm/M L=1.0M White+PTC	SCALE	1						
PART NO	RD90.LZH0220901-003	UNIT	mm						
VEIW ANGLE		DATE	2022.09.01						
		SHEET	1 of 1						

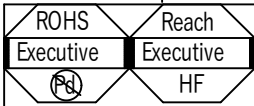

REV	ECN NO.	DETAILS	BY	DATE
1	A0	new version release	LZH	2022/09/19
2	A1	端子线30AWG更新为24AWG, 增加出线位置, 其他不变	LZH	2022/10/17
3				

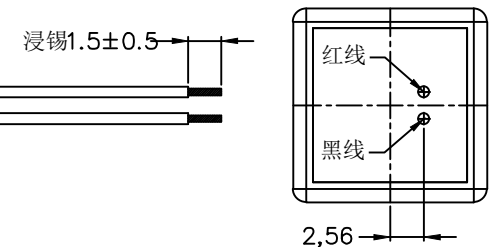
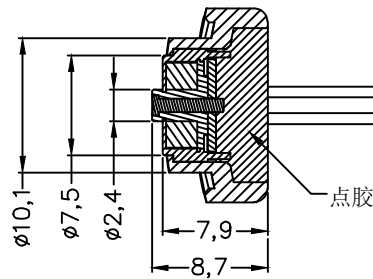
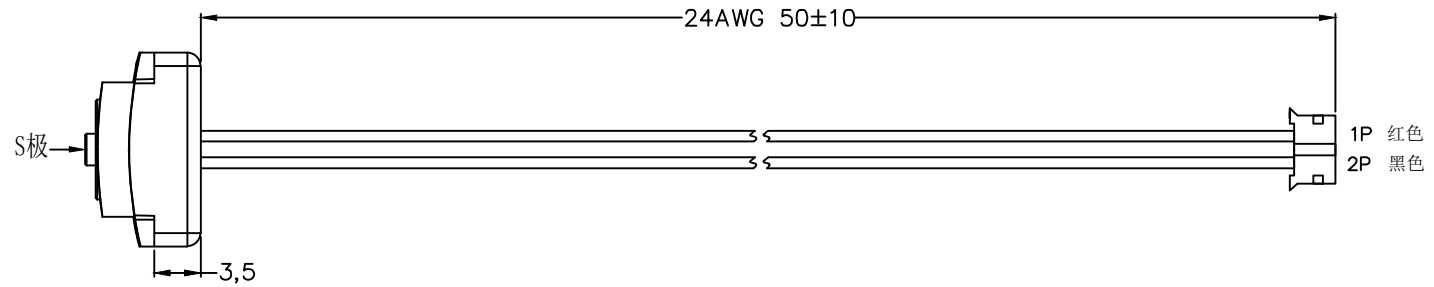
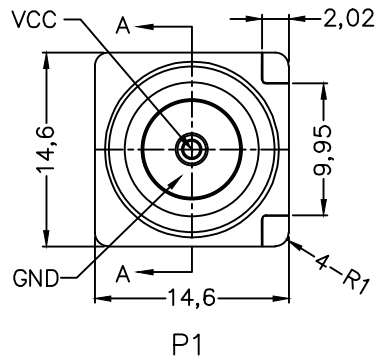

CONNECT DIAGRAM

P1  
 VCC+ Red 1P  
 GND- Black 2P

Technical Specification:

- 1.0 a.100% break/short test.
- b.On-resistance: 0.3 $\Omega$  (max).
- c.Insulation resistance: 300V/DC 10M $\Omega$ (min).
- 2.0 Rated voltage (PIN contact): 5Volts
- 3.0 Rated current (PIN contact): 2A maximum
- 4.0 Waterproof grade: IP67
- 5.0 Operating temperature range: -40~85 $\tau$
- 6.0 is marked with "\*" as a key dimension.

7	electrode ring	H59	Nickel plated after 48 hours of salt spray	1pcs	-
6	magnet	N52	Nickel plated after 24 hours of salt spray	1pcs	-
5	PCB	FR-4	Halogen free	1pcs	-
4	PIN	HBI59-1.5	Ni1.5~3.0um+Au0.125um	1pcs	-
3	Housing	PA9T White	Halogen Free Fire Resistant	1pcs	-
2	enclosure	PC+ABS White	Halogen Free Fire Resistant	1pcs	-
1	Terminal wire	-	UL1007 24AWG Red,Black PH2.0	1pcs	-
Item	Part Name	Material	Finish	Q'TY	Remarks

\*UNLESS OTHERWISE STATED  
 ALL DIMENSIONS ARE IN  
 MILLIMETRES  
 LINEAR TOLERANCE:  
 X:±0.20 .X±0.15 .XX±0.10  
 X\*±2° .X\*±0.5°  
 Pomagtor  
 Website:www.pomagtor.net

**POMAGTOR**  
 PROFESSIONAL CUSTOMIZATION SINCE 2007  
 HIGH FREQUENCY POGO PIN MAGNETIC CONNECTOR

ITEM	Magnetic attraction line	REV	A1	DRAWN BY	CHECKED BY	APPROVED BY
S/N.	-	SCALE	1	LZH		
RD.S/N.	RD90.LZH0220919-002	UNIT	mm			
VEIW ANGLE		DATE	2022/10/17			
		SHEET	1 of 1			