

版本	变更描述	设计	批准	日期
A0	新版本发行			

变更记录

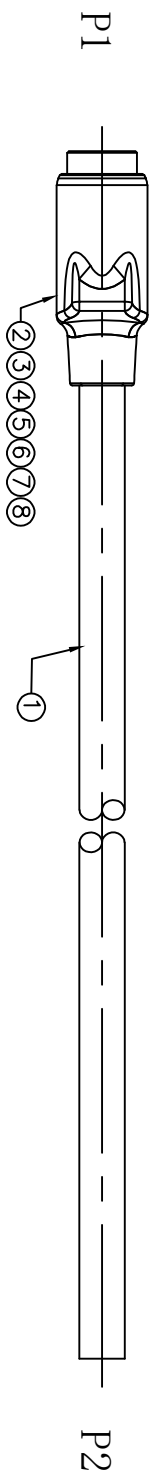
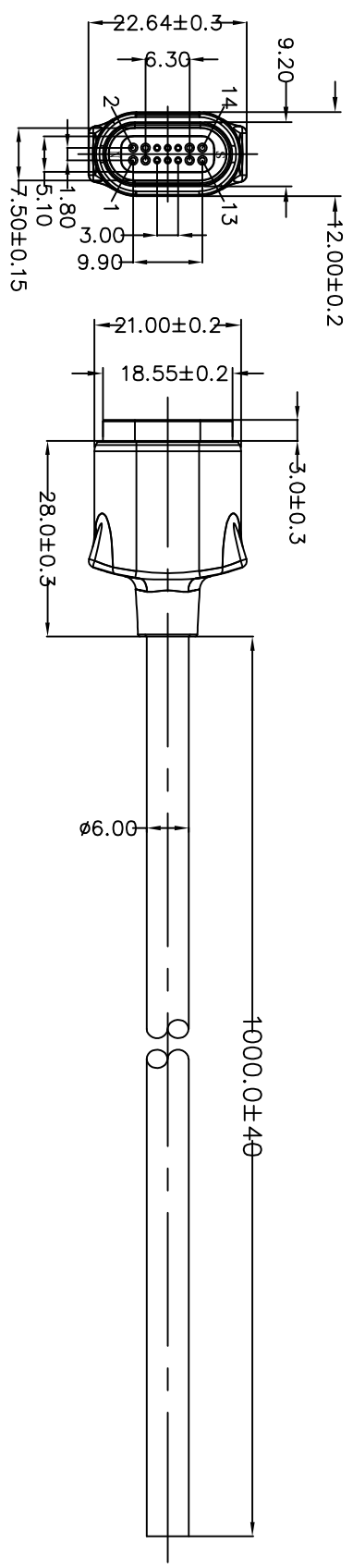

接线表

- NOTES:
- OPEN/SHORT/INTERMITTENCE 100% TEST;
 - CONTACT RESISTANCE: 30 (max);
 - INSULATION RESISTANCE: DC 300V/0.1sec; 10M (MIN)
 - Rated voltage (Per Contact): 5Volts;
 - Rated Current (Per Contact): 1A max;
 - Recommended Working Stroke & Force:
 - Stroke 0.8mm (Per Contact); 50gf Max;
 - Mechanical life:
 - 0.8mm (Mechanical life): 10,000 times;
 - Working Temperature Range: -30~85°;
 - Magnet GAUSE value: 3700GSS±400;
 - Salt spray test: 48H.

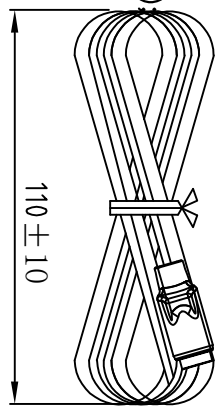

P1	P2
1 GND (地)	open
2 BROWN (棕)	open
3 Red (红)	open
4 ORANGE (橙)	open
5 Red-红 (Core-芯)	open
6 Red-红 (GND-地)	open
7 Green-绿 (Core-芯)	open
8 Green-绿 (GND-地)	open
9 Blue-蓝 (Core-芯)	open
10 Blue-蓝 (GND-地)	open
11 YELLOW (黄)	open
12 GREEN (绿)	open
13 BLUE (蓝)	open
14 BRAID (编织)	open

10						
9						
8	311-01001045-001	P V C	PVC 45P COLOR:BLACK BK001	10.0	g	
7	307-00000248-001	P E	LDPE #248	8.0	g	
6	801-15008510-001	PogoPin	Ø1.5*8.5 Contact plating:brass Au10u" over 50-120u" Ni	8	PCS	
5	801-12008510-001	PogoPin	Ø1.2*8.5 Contact plating:brass Au10u" over 50-120u" Ni	6	PCS	
4	400-21295606-001	PCB	FR4, L12, 65*W6, 0*10, 6mm	1	PCS	
3	515-17157850-001	MAGNET	Material:NE2, SIZE:L17.15*W7.8*H5.0mm, Ni plate 200u"	1	PCS	
2	200-14015M12001	CONNECTOR	TK-14P POGO PIN MAGNET CONNECTOR INSULATOR PA46+30%GF COLOR BLACK PIN Gild 100u"	1	PCS	
1	115-09101060001	CABLE	UL20276 [7/0.12*IC+S (32/0.1)+WVAL*3C]+7/0.12*6C+A+E (7/0.127)+B (128/0.10), OD=6.0MM, 黑色PVC外被	1.03	M	
Item	Material Coding	Name	Specifications Description	QTY	UNIT	

POMAGTOR 磁性连接器—专业为客定制

深圳市泰科汉泽精密电子有限公司
Pomagtor Precision Electronics

未注公差	视图	品名描述	14PIN磁吸线, 材料PVC(黑色), 长度1M
±0.20	绘图	公司料号	HR91.TK012-001 客户料号
±0.15	审核	图档编号	
±0.10	核准	页码	
±0.05		比例	1:1
		版本	A0
		单位	mm



变更记录

版本号	变更描述	日期	设计者
A0	新制定	2018.09.20	

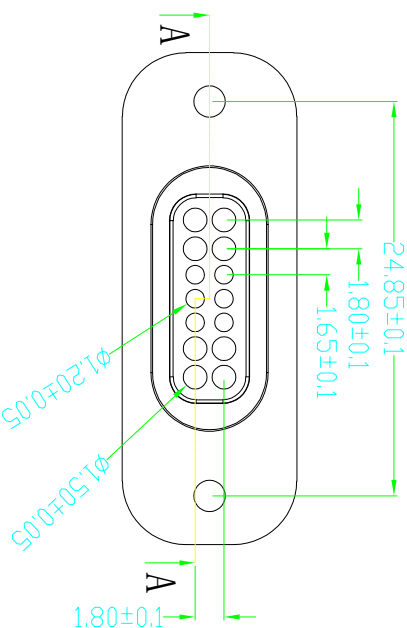
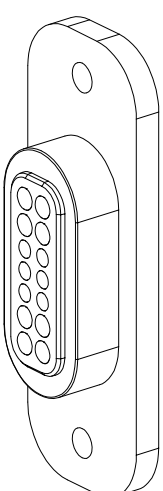
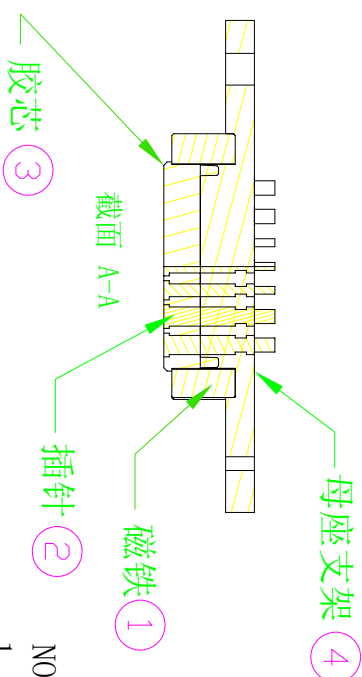
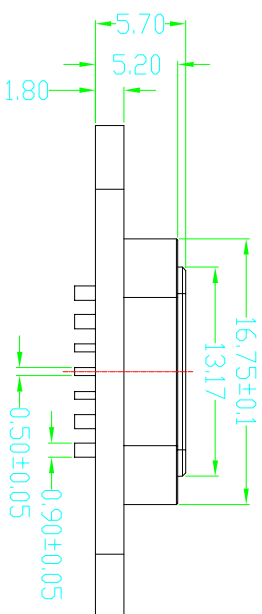
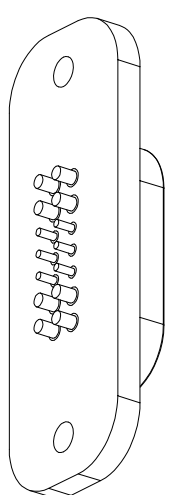
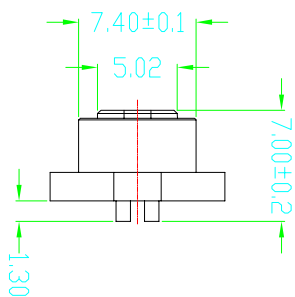
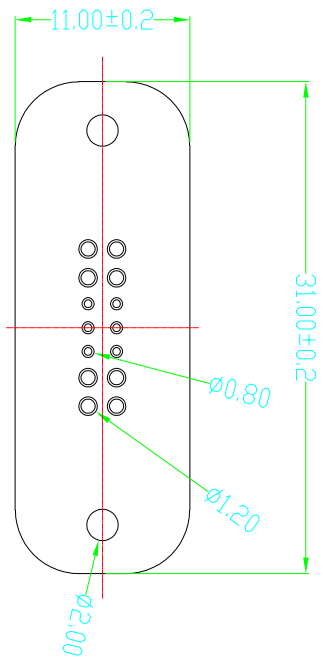

- NOTES:
1. 产品表面无披锋、缩水、变形、脏污、杂色等不良现象;
 2. 材质: LCP 黑色
 3. 额定电压: 24V
 4. 额定电流: 5.0A (最大)
 5. 绝缘阻抗: 100MΩ (最小)
 6. 导通阻抗: 25mΩ (最大)
 7. 工作温度: -30~85°
 - 8.

项次	零件名称	规格描述	用量	品名描述	料号	图档编号	单位	版本
4	母座支架	TK-14PIN 母座支架塑胶 PA46 黑色	5g	POMAGTOR 磁性连接—专业为您定制 深圳市泰科汉泽精密电子有限公司 Pomagtor Precision Electronics	TK-14PIN母座 连接器		mm	A0
3	母座胶芯	TK-14PIN 母座胶芯 LCP 黑色	1PCS		HY80.00555-001			
2	插针	1.2*7.0 插针, C3604 电镀镍50~80u“金5u”	6PCS					
1	磁铁	JH 7PIN 母座磁铁 材质N52 L16.75*W7.4*H4.0mm 镀镍200u” 盐雾48H	1PCS					
项次				用量	视角	公差:		
						x. ±0.20 x° ±0.5° .x ±0.15 .x° ±0.5° .xx ±0.10 .xx ±0.10		